

iS ***Rayfast***

Features

Plug-in power relays:
8 A, 2 pole
12 A, 2 and 4 pole

- Complies with **UNI CEI 11170-3** (protection against fire of materials), **EN 61373** (resistance against random vibrations and shock, Category 1, Class B), **EN 50155** (resistance to temperature and humidity, TX class)
- DC coils with extended range
- Cadmium Free contacts (standard version)
- Contact material options
- 97 and 96 series sockets
- Coil EMC suppression modules
- Accessories (Sockets and Timer modules)

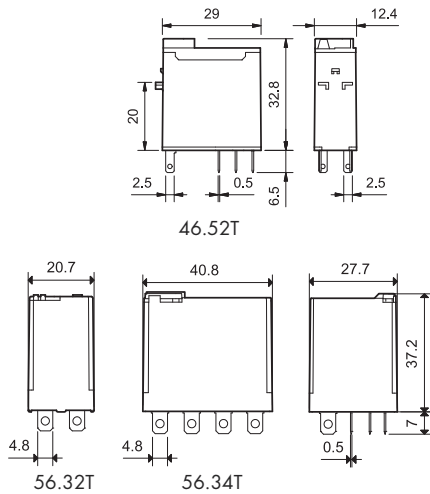

• 2 Pole CO, 8A
 • Plug-in



• 2 Pole CO, 12 A
 • Plug-in/Faston 187



• 4 Pole CO, 12 A
 • Plug-in/Faston 187

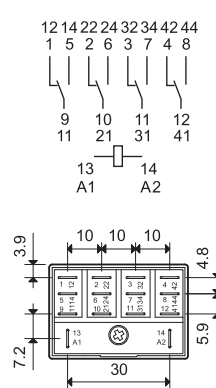
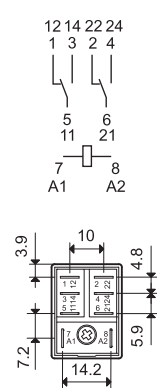
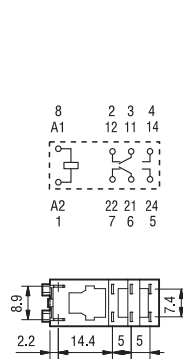

Contact specification				
Contact configuration		2 CO (DPDT)	2 CO (DPDT)	4 CO (4PDT)
Rated current/Maximum peak current	A	8/15	12/20	12/20
Rated voltage/Maximum switching voltage V AC		250/400	250/400	250/400
Rated load AC1	VA	2,000	3,000	3,000
Rated load AC15 (230 V AC)	VA	350	700	700
Single phase motor rating (230 V AC)	kW	0.37	0.55	0.55
Breaking capacity DC1: 30/110/220 V	A	6/0.5/0.15	12/0.5/0.25	12/0.5/0.25
Minimum switching load	mW (V/mA)	300 (5/5)	500 (10/5)	500 (10/5)
Standard contact material		AgNi	AgNi	AgNi
Coil specification				
Nominal voltage (U _N)	V AC (50/60 Hz)	—	—	—
	V DC	24 - 72 - 110	24 - 72 - 110	24 - 72 - 110
Rated power	W	0.5	1	1.3
Operating range @ 23 °C	AC	—	—	—
	DC	(0.70...1.6) U _N	(0.70...1.6) U _N	(0.70...1.6) U _N
Holding voltage		0.4 U _N	0.6 U _N	0.6 U _N
Must drop-out voltage		0.1 U _N	0.1 U _N	0.1 U _N
Technical data				
Mechanical life DC	cycles	10 · 10 ⁶	10 · 10 ⁶	10 · 10 ⁶
Electrical life at rated load AC1	cycles	100 · 10 ³	100 · 10 ³	100 · 10 ³
Operate/release time	ms	10/3	8/8	8/8
Insulation between coil and contacts (1.2/50 μs)	kV	6 (8 mm)	4	4
Dielectric strength between open contacts	V AC	1,000	1,000	1,000
Ambient temperature range	°C	-40...+70	-40...+70	-40...+70
Environmental protection		RT II	RT I	RT I
Approvals (according to type)		CE	CE	CE

Ordering information

Example: 46 series plug-in relay, 2 poles, 24 V DC coil, AgNi contacts.

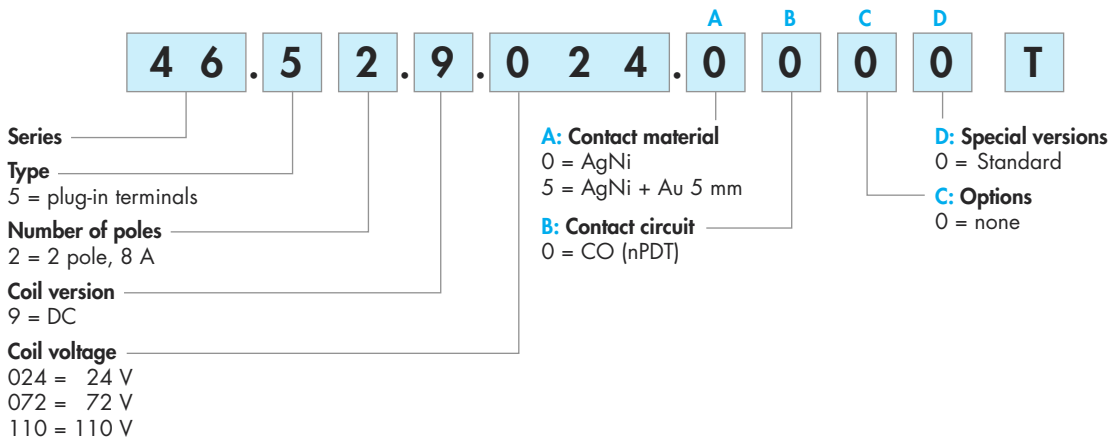

Example: 56 series plug-in relay, 4 poles, 24 V DC coil, AgCdO contacts.

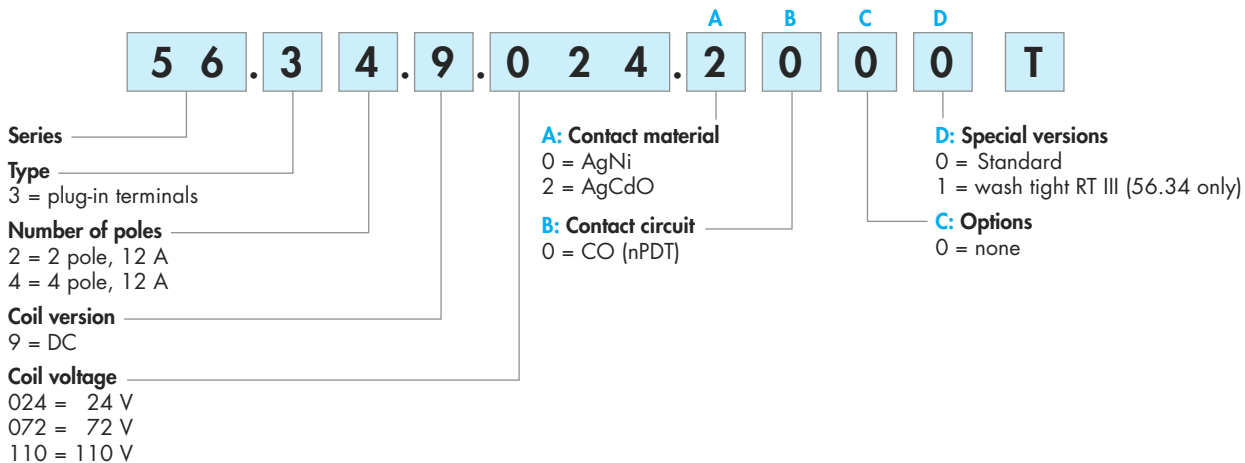

Technical data

Insulation according to EN 61810-1		46.52T		56.32T/34T	
Nominal voltage of supply system	V AC	230/400		230/400	
Rated insulation voltage	V AC	250	400	250	400
Pollution degree		3	2	3	2
Insulation between coil and contact set					
Type of insulation		Reinforced (8 mm)		Basic	
Overvoltage category		III		III	
Rated impulse voltage	kV (1.2/50 µs)	6		4	
Dielectric strength	V AC	4,000		2,500	
Insulation between adjacent contacts					
Type of insulation		Basic		Basic	
Overvoltage category		III		III	
Rated impulse voltage	kV (1.2/50 µs)	4		4	
Dielectric strength	V AC	2,000		2,500	
Insulation between open contacts					
Type of disconnection		Micro-disconnection		Micro-disconnection	
Dielectric strength	V AC/(1.2/50 µs)	1,000/1.5		1,000/1.5	
Conducted disturbance immunity					
Burst (5...50)ns, 5 kHz, on A1 - A2	EN 61000-4-4	level 4 (4 kV)		level 4 (4 kV)	
Surge (1.2/50 µs) on A1 - A2 (differential mode)	EN 61000-4-5	level 3 (2 kV)		level 4 (4 kV)	
Other data					
Bounce time: NO/NC	ms	1/4		1/3	
Power lost to the environment	without contact current	W	0.6	1 (56.32) / 1.3 (56.34)	
	with rated current	W	2	3.8 (56.32) / 6.9 (56.34)	

Contact specification

F 46 - Electrical life (AC) v contact current - Type 46.52T

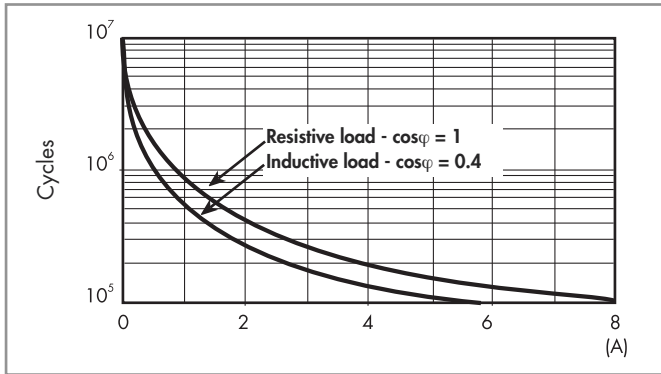

F 56 - Electrical life (AC) v contact current - Type 56.32T and 56.34T

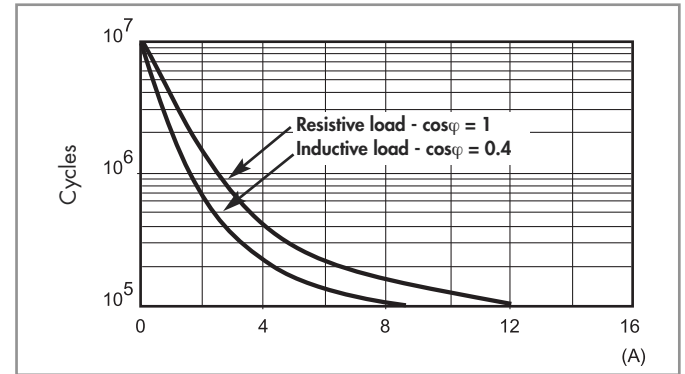

H 46 - Maximum DC1 breaking capacity - Type 46.52T

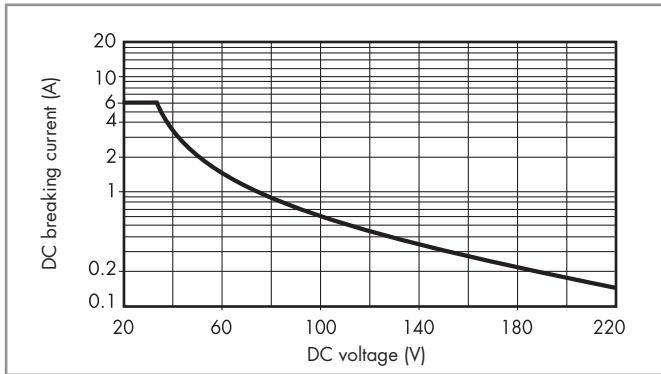

H 56 - Maximum DC1 breaking capacity - Type 56.32T and 56.34T

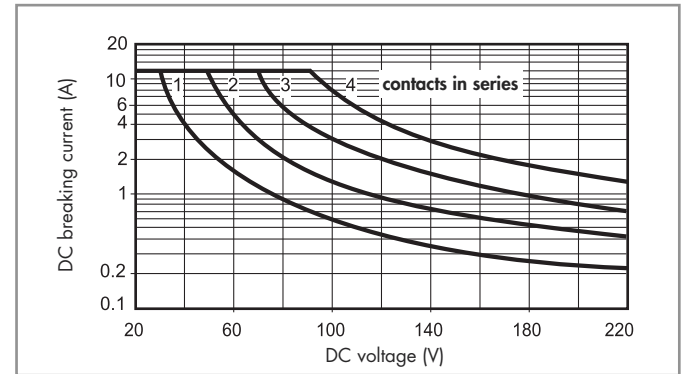

- When switching a resistive load (DC1) having voltage and current values under the curve, an electrical life of $\geq 100 \cdot 10^3$ can be expected.
- In the case of DC13 loads, the connection of a diode in parallel with the load will permit a similar electrical life as for a DC1 load.
Note: the release time for the load will be increased.

Coil specifications

DC coil data, 2 CO - Type 46.52T @ 23 °C

Nominal voltage U_N	Coil code	Operating range		Resistance R	Rated coil consumption I at U_N
		U_{min}	U_{max}		
V		V	V	Ω	mA
24	9.024	16.8	38	1,200	20
72	9.072	50.4	115	3,400	7
110	9.110	77	176	23,500	4.7

DC coil data, 2 CO - Type 56.32T @ 23 °C

Nominal voltage U_N	Coil code	Operating range		Resistance R	Rated coil consumption I at U_N
		U_{min}	U_{max}		
V		V	V	Ω	mA
24	9.024	16.8	38	600	40
72	9.072	50.4	115	5,100	14
110	9.110	77	176	12,500	8.8

Other types of coil version are available on request.

DC coil data, 4 CO - Type 56.34T @ 23 °C

Nominal voltage U_N	Coil code	Operating range		Resistance R	Rated coil consumption I at U_N
		U_{min}	U_{max}		
V		V	V	Ω	mA
24	9.024	16.8	38	490	49
72	9.072	50.4	115	4,000	18
110	9.110	77	176	10,400	10.5

RT 46T / 56T - DC coil operating range v ambient temperature

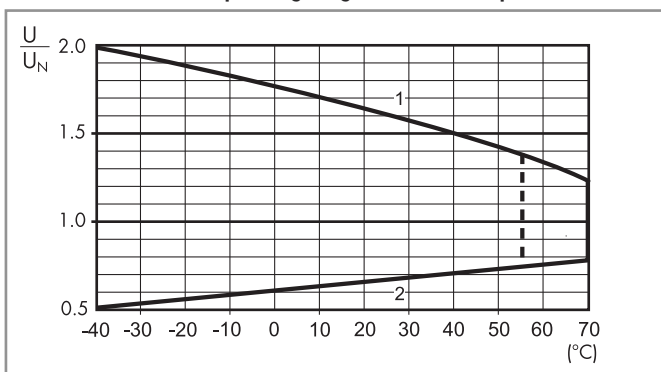

- 1 - Max. permitted coil voltage.
- 2 - Min. pick-up voltage with coil at ambient temperature.

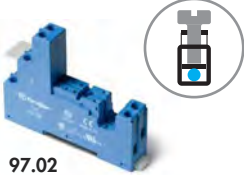

97.02

Approvals
(according to type):



Screw terminal socket panel or 35 mm rail (EN 60715) mount	97.02 SMA*	
For relay type	46.52T	
Accessories		
Metal retaining clip (supplied with socket - packaging code SMA)	097.71	
8-way jumper link	095.18	
Modules (see table below)	99.02T	
Timer modules (see table below)	86.30T	
Technical data		
Rated current	8 A - 250 V AC	
Dielectric strength	6 kV (1.2/50 μs) between coil and contacts	
Protection category	IP 20	
Ambient temperature	°C	-40...+70
Screw torque	Nm	0.8
Wire strip length	mm	8
Max. wire size for 97.02 socket	solid wire	stranded wire
	mm ²	1x6 / 2x2.5
	AWG	1x10 / 2x14

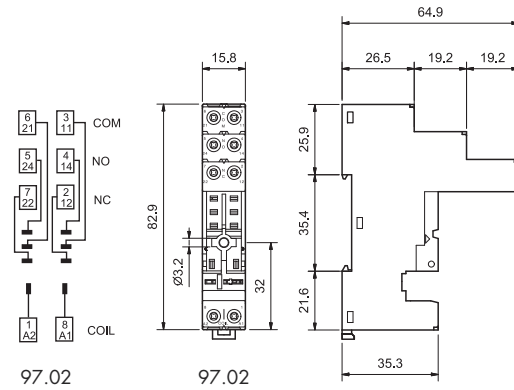

* Complies with **UNI CEI 11170-3** (protection against fire of materials), **EN 61373** (resistance against random vibrations and shock, Category 1, Class B), **EN 50155** (resistance to temperature and humidity, TX class)



095.18

8-way jumper link for 97.02 socket	095.18
Rated values	10 A - 250 V

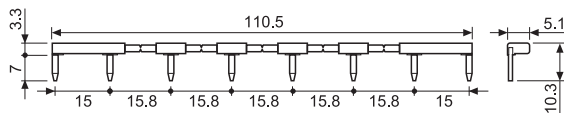

86 series timer module	
(12...24)V AC/DC; Bi-function: AI, DI; (0.05s...100h)	86.30.0.024.0000T

Approvals (according to type):

AI: ON-delay
DI: Interval

86.30T



99.02 coil indication and EMC suppression modules for 97.02 socket	
---	--

Diode (+A1, standard polarity)	(6...220)V DC	99.02.3.000.00T
LED + Diode (+A1, standard polarity)	(6...24)V DC	99.02.9.024.99T
LED + Varistor	(6...24)V DC/AC	99.02.0.024.98T

99.02T

Approvals
(according to type):



DC Modules with
non-standard polarity
(+A2) on request.





97.52

Approvals
(according to type):



Screwless terminal socket panel or 35 mm rail (EN 60715) mount		97.52 SMA*
For relay type		46.52T
Accessories		
Metal retaining clip (supplied with socket - packaging code SMA)		097.71
Modules (see table below)		99.02T
Timer modules (see table below)		86.30T
Technical data		
Rated current		8 A - 250 V AC
Dielectric strength		6 kV (1.2/50 μs) between coil and contacts
Protection category		IP 20
Ambient temperature		°C -25...+70
Wire strip length		mm 8
Max. wire size for 97.52 socket		solid wire
		mm ² 2x(0.2...1.5)
		stranded wire 2x(0.2...1.5)
		AWG 2x(24...18)
		2x(24...18)

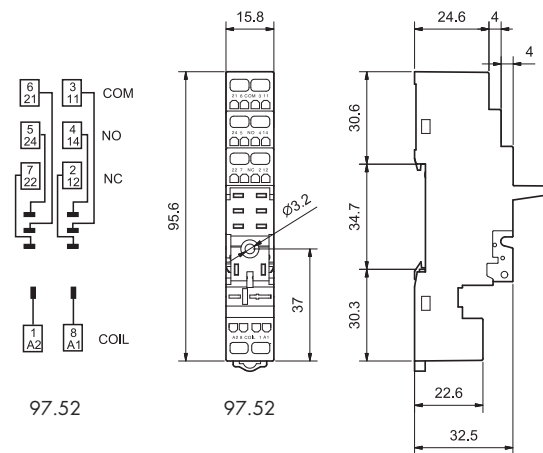
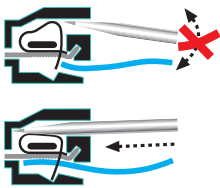
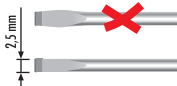

* Complies with **UNI CEI 11170-3** (protection against fire of materials), **EN 61373** (resistance against random vibrations and shock, Category 1, Class B), **EN 50155** (resistance to temperature and humidity, TX class)



86.30T

86 series timer module	
(12...24)V AC/DC; Bi-function: AI, DI; (0.05s...100h)	86.30.0.024.0000T

Approvals (according to type):

AI: ON-delay
DI: Interval



99.02T

Approvals
(according to type):



99.02 coil indication and EMC suppression modules for 97.52 socket		
Diode (+A1, standard polarity)	(6...220)V DC	99.02.3.000.00T
LED + Diode (+A1, standard polarity)	(6...24)V DC	99.02.9.024.99T
LED + Varistor	(6...24)V DC/AC	99.02.0.024.98T

DC Modules with non-standard polarity (+A2) on request.

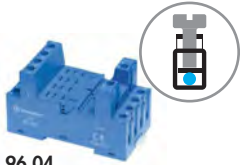

96.04
Approvals
(according to type):



Screw terminal (Box clamp) socket panel or 35 mm (EN 60715) rail mount	96.02 SMA*	96.04 SMA*	
For relay type	56.32T	56.34T	
Accessories			
Metal retaining clip (supplied with socket - packaging code SMA)	094.71	096.71	
Modules (see table below)	99.02T		
Timer modules (see table below)	86.00T, 86.30T		
Technical data			
Rated values	12 A - 250 V		
Dielectric strength	2 kV AC		
Grado di protezione	IP 20		
Protection category	°C -40...+70 (see diagram L96)		
⊕ Screw torque	Nm	0.8	
Wire strip length	mm	8	
Max. wire size for 96.02 and 96.04 socket	solid wire	stranded wire	
	mm ²	1x6 / 2x2.5	1x4 / 2x2.5
	AWG	1x10 / 2x14	1x12 / 2x14

* Complies with **UNI CEI 11170-3** (protection against fire of materials), **EN 61373** (resistance against random vibrations and shock, Category 1, Class B), **EN 50155** (resistance to temperature and humidity, TX class)

L 96 - Rated current vs ambient temperature

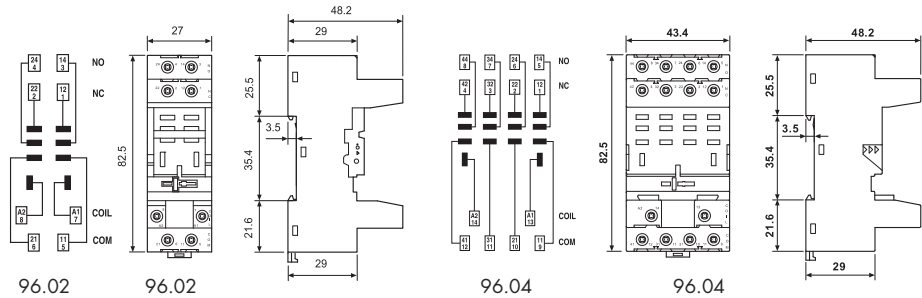
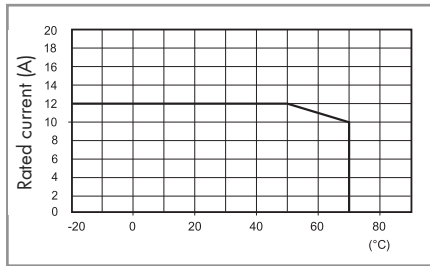

86.00T



86.30T



99.02T

Approvals
(according to type):



DC Modules with
non-standard polarity
(+A2) on request.

86 series timer modules		
Multi-voltage: (12...240)V AC/DC;		
Multi-functions: AI, DI, SW, BE, CE, DE, EE, FE; (0.05 s...100 h)		86.00.0.240.0000T
(12...24)V AC/DC; Bi-function: AI, DI; (0.05 s...100 h)		86.30.0.024.0000T

Approvals (according to type):

- AI: ON-delay
- DI: Interval
- SW: Symmetrical flasher (starting pulse on)
- BE: Off-delay with control signal
- CE: On- and off-delay with control signal
- DE: Interval with control signal on
- EE: Interval with control signal off
- FE: Interval with control signal on and off

99.02 coil indication and EMC suppression modules for 96.02 and 96.04 socket		
Diode (+A1, standard polarity)	(6...220)V DC	99.02.3.000.00T
LED + Diode (+A1, standard polarity)	(6...24)V DC	99.02.9.024.99T
LED + Varistor	(6...24)V DC/AC	99.02.0.024.98T



Tel: +44(0) 1793 616700 • Email: uksales@is-rayfast.com
Email: export@is-rayfast.com • www.is-rayfast.com
2 Lydiard Fields, Swindon, Wiltshire, SN5 8UB, United Kingdom